

MODEL: 5LBS6042AFR*

REMODELER

*ALL ACCESSORIES OPTIONAL

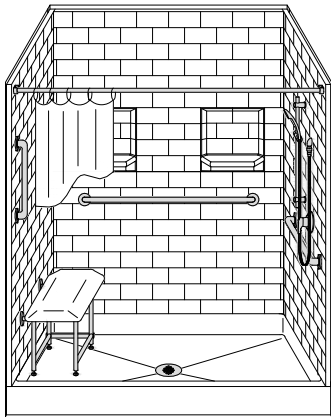

PERSPECTIVE VIEW - N.T.S.

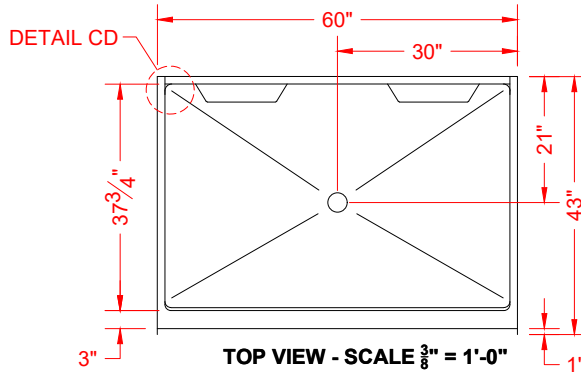

Features:

- Molded, five-piece gelcoat/fiberglass barrier free shower module
- "Subway Tile", 4" x 8" simulated tile wall finish, white (standard)
- Integral full wood backing for strength and unlimited accessory placement
- Above floor rough allows for a minimum of 3" clearance from the bottom of the drain recess to the sub floor

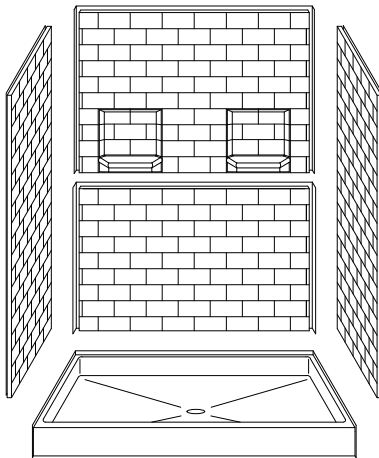

ASSEMBLY VIEW - N.T.S.

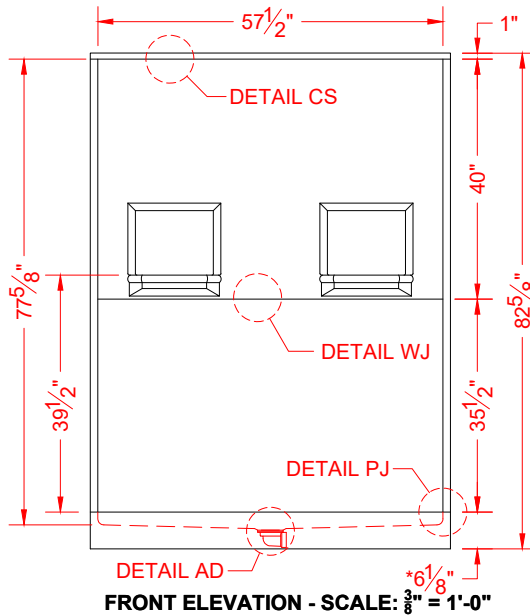

***OTHER THRESHOLD HEIGHTS AVAILABLE UPON REQUEST
MAX TRIM HEIGHT OF 7-1/2"**

* - SEE BACK FOR DETAIL SECTIONS

PRODUCT SPECIFICATIONS:

- Multi-piece shower module shall be constructed of gelcoat/fiberglass with full integral plywood backing
- Rough-In: Stud opening +1/4" -0" Nominal Dimensions.

C.S.I. FORMAT SPECIFICATION TEXT AVAILABLE

PRODUCT INFORMATION:

- Accessories: Factory installed, unless prone to damage during installation/shipping. Polished chrome/satin stainless standard, others available.
- Colors: White as standard, others to match any major fixture manufacturer, also available with sprayable solid surface in many colors
- Custom curb heights, other than shown, are available (between min. and max.)

OPTIONAL ACCESSORIES:

INSTALLED BY OTHERS:

- Grab bar
- Seat, folding
- Mixing valve, pressure-balancing, lever handle, pre-plumbed tee to supply elbow
- Curtain and rod
- No-caulk brass drain
- Soap dish

CODES:

- Designed and manufactured in compliance with the following standards and codes:
- ANSI Z124.2 Standards for Plastic Showers
 - IPC International Plumbing Code
 - UPC Uniform Plumbing Code

NOTICE OF LIMITATION:

- Adhere to floor as required



We reserve the right to make revisions without notice in the design of fixtures or in packaging unless this right has specifically been waived at the time the order is accepted.

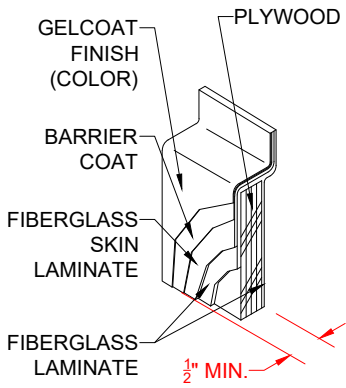

DETAIL CS - SCALE: 3" = 1'-0"
CROSS SECTION DETAIL

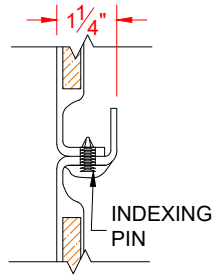

DETAIL WJ - SCALE: NTS
WALL JOINT DETAIL

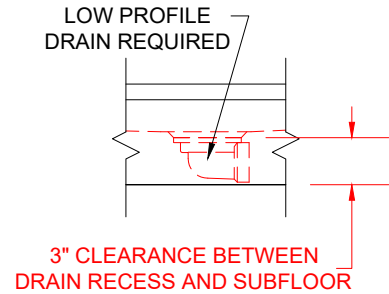

DETAIL AD SCALE: NTS
AFR DETAIL

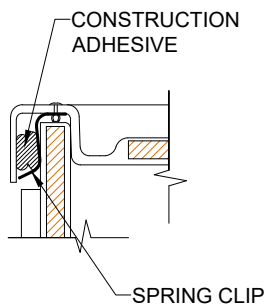

DETAIL CD - SCALE: NTS
CORNER JOINT DETAIL

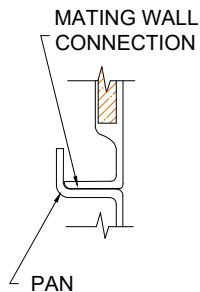

DETAIL PJ - SCALE: NTS
PAN JOINT DETAIL