

# MODEL: 5LBS6032FBSQA\*FR\* L/R

# REMODELER

\*ALL ACCESSORIES OPTIONAL

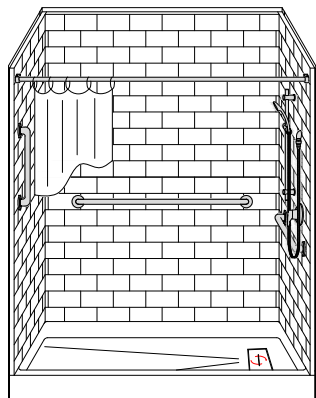

**PERSPECTIVE VIEW - N.T.S.**  
MODEL SHOWN HERE AS:  
RIGHT DRAIN

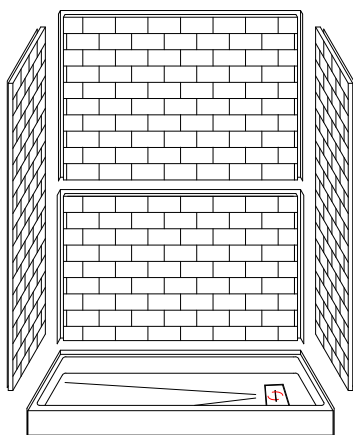

**ASSEMBLY VIEW - N.T.S.**

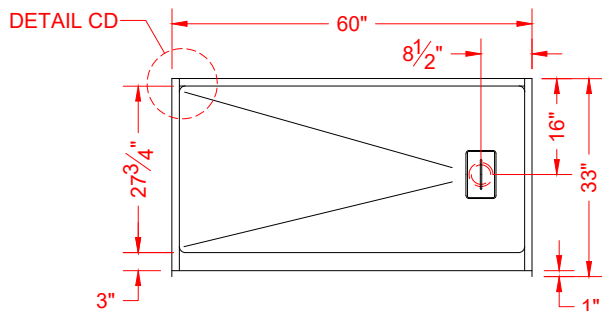

**TOP VIEW - SCALE  $\frac{3}{8}'' = 1'-0''$**

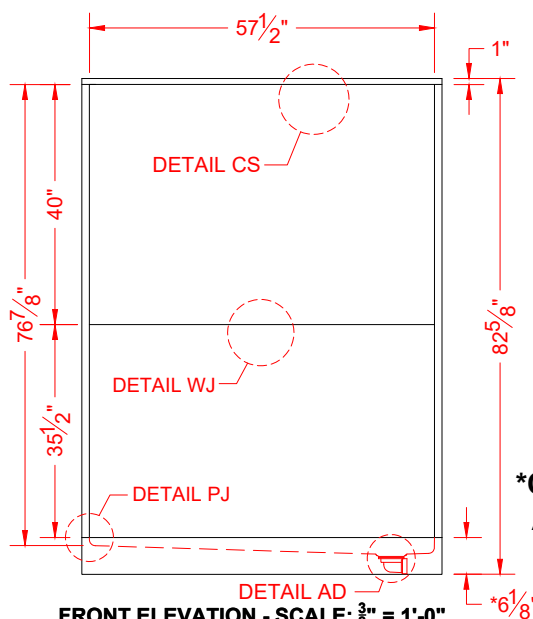

**FRONT ELEVATION - SCALE:  $\frac{3}{8}'' = 1'-0''$**

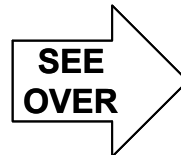

## Features:

- Molded, five-piece gelcoat/fiberglass shower module
- "Subway Tile", 4" x 8" simulated tile wall finish, white (standard)
- Integral full wood backing for strength and unlimited accessory placement
- Above floor rough allows for a minimum of 3" clearance from the bottom of the drain recess to the sub floor

**\*OTHER THRESHOLD HEIGHTS AVAILABLE UPON REQUEST  
MAX TRIM HEIGHT OF 7-1/2"**

\* - SEE BACK FOR DETAIL SECTIONS

## PRODUCT SPECIFICATIONS:

- Multi-piece shower module shall be constructed of gelcoat/fiberglass with full integral plywood backing
- Rough-In: Stud opening +1/4" -0" Nominal Dimensions.

C.S.I. FORMAT SPECIFICATION TEXT AVAILABLE

## PRODUCT INFORMATION:

- Accessories: Factory installed, unless prone to damage during installation/shipping. Polished chrome/satin stainless standard, others available.
- Colors: White as standard, others to match any major fixture manufacturer, also available with sprayable solid surface in many colors
- Custom curb heights, other than shown, are available (between min. and max.)

## OPTIONAL ACCESSORIES:

- INSTALLED BY OTHERS:
- Seat, folding
  - Grab bar
  - Soap dish
  - Mixing valve, pressure-balancing, lever handle, pre-plumbed tee to supply elbow
  - Curtain rod brackets
  - Curtain and rod
  - Drain grate and No-caulk brass drain (INCLUDED)

## CODES:

- Designed and manufactured in compliance with the following standards and codes:
- ANSI Z124.2 Standards for Plastic Showers
  - ANSI A117.1 B - Accessible and Usable Buildings and Facilities
  - IPC International Plumbing Code
  - UPC Uniform Plumbing Code

## NOTICE OF LIMITATION:



*We reserve the right to make revisions without notice in the design of fixtures or in packaging unless this right has specifically been waived at the time the order is accepted.*

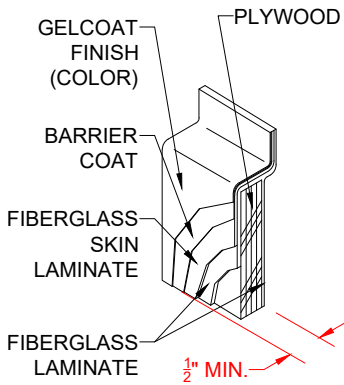

**DETAIL CS - SCALE: N.T.S.**  
**CROSS SECTION DETAIL**

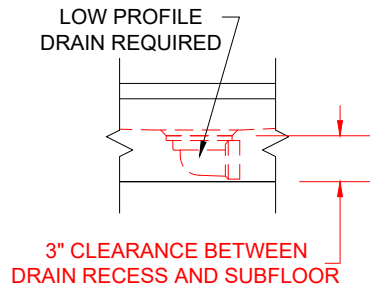

**DETAIL AD - SCALE: N.T.S.**  
**AFR DETAIL**

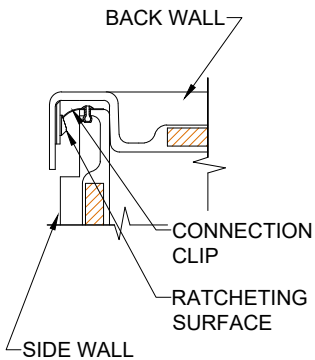

**DETAIL CD - SCALE: 3" = 1'-0"**  
**CORNER DETAIL**

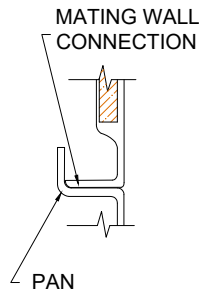

**DETAIL PJ - SCALE: 3" = 1'-0"**  
**PAN JOINT DETAIL**

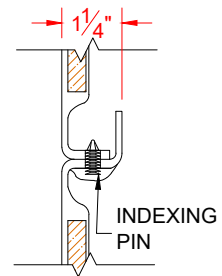

**DETAIL WJ - SCALE: 3" = 1'-0"**  
**WALL JOINT DETAIL**